

Helios, a CyTOF system

SITE REQUIREMENTS GUIDE



For Research Use Only. Not for use in diagnostic procedures.

Information in this publication is subject to change without notice. It is Fluidigm policy to improve products as new techniques and components become available. Therefore, Fluidigm reserves the right to change specifications at any time. Every effort has been made to avoid errors in the text, diagrams, illustrations, figures, and screen captures. However, Fluidigm assumes no responsibility for any errors or omissions. In no event shall Fluidigm be liable for any damages in connection with or arising from the use of this publication.

Patent and Limited License Information

Fluidigm products are covered by issued and pending patents in the United States and other countries. Patent and limited license information is available at fluidigm.com/legalnotices

Trademarks

Fluidigm, the Fluidigm logo, CyTOF, and Helios are trademarks or registered trademarks of Fluidigm Corporation in the United States, and/or other countries. All other trademarks are the sole property of their respective owners.

For EU's WEEE directive information, go to fluidigm.com/compliance

© 2017 Fluidigm Corporation. All rights reserved. 01/2017

PN 400252 A5

C7-SM-04 rev 5

For technical support visit fluidigm.com/support

EMAIL

North America support.northamerica@fluidigm.com

Europe support.europe@fluidigm.com

Asia techsupportasia@fluidigm.com

Latin America techsupportlatam@fluidigm.com

All other countries techsupport@fluidigm.com

PHONE

United States (toll-free) +1 866 358 4354

Europe +33 1 60 92 42 40

Japan +81 3 3662 2150

China (excluding Hong Kong) +86 21 3255 8368

All other countries +1 650 266 6100

Contents

About This Guide	4
Safety Alert Words	4
Safety Data Sheets	4
Chapter 1: Introduction	5
Instrument Dimension and Layout	6
Crate Information	6
Helios Information	6
Chapter 2: Requirements	9
Electrical Specifications	9
Plug Information	11
Uninterruptible Power Supply Recommendation	12
Gas Requirements	13
Argon Specification	13
Safe Handling of Gas Cylinders	14
Exhaust Requirement	15
Exhaust Positions	15
Flow Rates	16
Exhaust System Recommendations	17
Environmental Requirements	19
Additional Site Recommendations	19
Institutional network connectivity	19
Internet connectivity	20
Telephone access	20
Materials Required for Operation	21
Summary	22
Appendix A: Safety	23
General Safety	23
Instrument Safety	23
Instrument Symbols	24
Chemical Safety	25

About This Guide



CAUTION ABBREVIATED SAFETY ALERTS. Hazard symbols and hazard types specified in procedures may be abbreviated in this document. For complete safety information, see Appendix A.

Safety Alert Words

This guide uses specific conventions for presenting information that may require your attention. Refer to the following safety alert conventions:



DANGER An imminent hazard that will result in severe injury or death if not avoided.



WARNING A potentially hazardous situation which if not avoided could result in serious injury or death.



CAUTION A potentially hazardous situation which if not avoided could result in minor or moderate personal injury.

IMPORTANT Information that is necessary for proper use of product or successful outcome of experiments.

Safety Data Sheets

Read and understand the safety data sheets (SDSs) before handling chemicals. The SDSs for chemicals ordered from Fluidigm Corporation, either alone or as part of this system, are available at fluidigm.com/sds

Some of the chemicals referred to in this user guide may not have been provided with your system. Obtain the SDSs from the manufacturers of chemicals not provided by Fluidigm.

Chapter 1: Introduction

This guide is designed to help you prepare for the reception and successful installation of your Helios™ instrument. The Helios mass cytometer is shipped to you as a complete system with the exception of the following items, which must be obtained prior to installation: electrical power, exhaust vents, and argon gas supply with approved regulator.

When preparing the laboratory for instrument installation by a Fluidigm field service engineer, the following items must be considered:

- Receiving the instrument
- System layout
- Network connectivity
- Electrical requirements
- Argon gas requirements
- Exhaust ventilation
- Environmental conditions
- Materials required for maintenance and operation

Instrument Dimension and Layout

Crate Information

The instrument is shipped in a crate and its components are shipped in a separate box. A standard pump truck with minimum rating for 1,600 lb is recommended for moving the crate if necessary. Once you have received the crate and the box, store them in a dry place not exposed to weather until the scheduled installation date. Table 1 provides the dimensions of the instrument crate and components box.

Table 1: Dimensions of the crated Helios™ system

Component	Width (cm/in)	Height (cm/in)	Depth (cm/in)	Weight (kg/lb)
Helios Crate	107/42	157/62	170/67	529/1166
Components Box	81/32	97/38	107/42	135/298

Helios Information

The Helios system consists of the main instrument, a refrigerated chiller (PN 101058/101859 in North America/Europe), the Helios sampler, and a system computer with workstation.



Figure 1: Helios system.

The dimensions of the instrument, chiller, and autosampler are given in Table 2.

NOTE The AS-5 autosampler is designed to rest on a separate cart. (Recommended supplier, Anthro MiniCart PN GT23BK). The system computer may be placed on a separate bench or computer table (not supplied).

Table 2: Dimensions of Helios, chiller, and autosampler

Component	Width (cm/in)	Height (cm/in)	Depth (cm/in)	Weight (kg/lb)
Helios	103/41	132/52	87/35	320/705
Chiller	38/15	64/25	67/27	81/178
Autosampler	39/16	24/10	36/14	20/44

It is recommended that the instrument be located near the required electrical gas supplies, and ventilation system ports. The length of the provided electrical cables is approximately 3.8 m or 12.5 ft. The Helios mass cytometer is on wheels and can be moved for service and regular maintenance if necessary.

Leave a space of at least 61 cm (24 in) behind the instrument to provide adequate clearance for the vent hoses as shown in Figure 2. Allow space (approximately 50 cm/20 in) on the right side of the instrument for access to the circuit breakers. Access for most service procedures is through the front of the instrument.

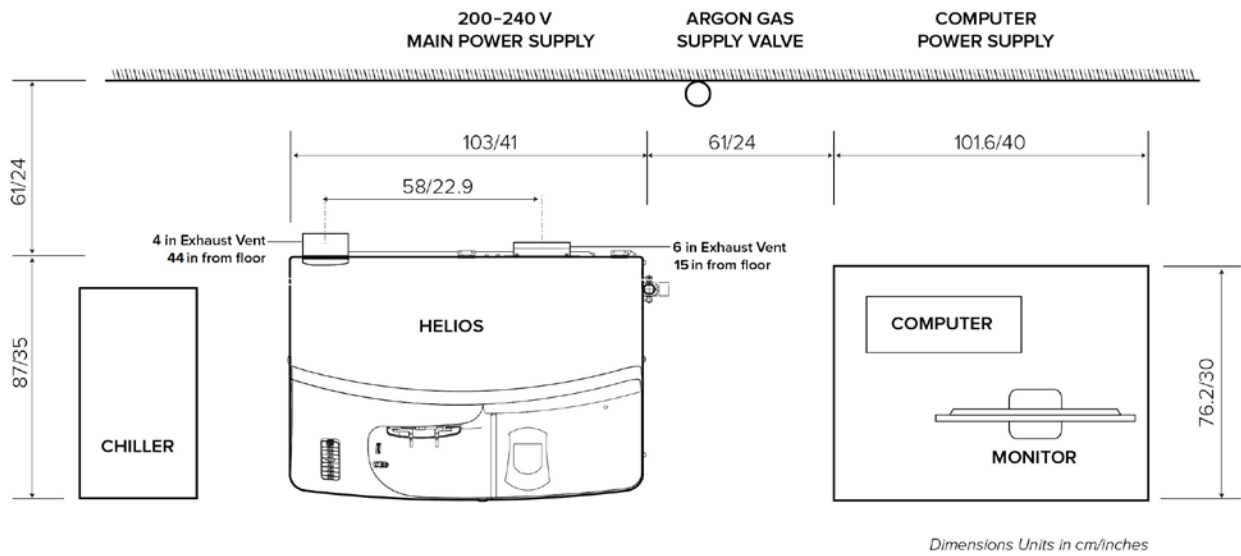

Figure 2: Footprint diagram of the Helios system and its accessories

The front and rear vents of the chiller must be a minimum of 24 inches (61 cm) away from walls or vertical surfaces so air flow is not restricted.

Chapter 2: Requirements

Electrical Specifications

Power to the Helios system is to be delivered from two 30 A single-phase 220–240 V AC, 50–60 Hz dedicated electrical branch circuits. Table 3 details the power specifications of the instrument and its accessories.

Table 3: Helios and accessories power consumption specifications

	Power Consumption, in volt amperes (VA)
Instrument	200/208/220/230/240
Maximum (two circuits)	2 x 4500
Accessories	
Chiller (powered through the instrument)	2300
Computer	1050
Autosampler (optional)	100

The operating range for the electrical supply is provided in Table 4. If the power line is unstable, fluctuates, or is subject to surges, additional control of the incoming power (e.g. surge protection or line conditioning) may be required.

Table 4: Helios electrical specifications

	Electrical Specification
Operating Voltage	200/208/220/230/240 V AC
Peak Current (per circuit)	30 A
Operating Frequency	50 or 60 Hz \pm 1 Hz
Maximum Allowable Percent Sag	5%
Maximum Allowable Percent Swell	5%
Maximum Supply Voltage Total Distortion	5%
Maximum Supply Voltage Distortion by Single Harmonics	3%
Phase (single or three)	Single or between two of the three phases

Plug Information

Table 5 provides the plug information for the instrument and accessories.

Table 5: Electrical specification for Helios instrument and accessories

Accessories	Voltage (V AC)	Current (A)
Helios	200/208/220/230/240	2 x 30
Chiller	Through Helios	13
Autosampler (optional)	100–240	<1
Computer	100–240	8
Monitor	110–230	<1

60 Hz Operation Connections

The instrument is shipped with two 3.8 m line cord cables. The installation kit includes two NEMA L6-30R plugs (250 V, 30 A) for use with two 60 Hz single phase outlets.

50 Hz Operation Connections

The instrument is shipped with two 3.8 m line cord cables. It is up to the service person installing the instrument to wire the cables with IP44 2P+E 32A (EU only). The single-phase connectors must be supplied by the customer.

NOTE Use plugs rated to the specified voltage according to the local code.

Connections to a three-phase power

Connection to a three-phase power may be required (by local electrical code). The instrument can be connected to two phases and to the ground wire of the three phase line. The three-phase plugs must be supplied by the customer.

Uninterruptible Power Supply Recommendation

If your Helios is installed in a region that has electrical voltage fluctuations exceeding $\pm 10\%$ of the normal value, it is strongly recommended that you protect the system with an uninterruptible power supply (UPS). Fluctuating voltage can compromise Helios. Table 6 outlines the recommended UPS.

Table 6: Recommended Uninterruptible Power Supply.

UPS	Voltage (kVA)	Manufacturer	Quantity
APC Smart UPS SRT 6000VA 208V	6	Schneider Electric	2*
APC Smart UPS SRT 10000VA 208V L630	10	Schneider Electric	1

* Two units of this item or one unit of the second item is recommended.

Gas Requirements

Argon Specification

Ultra High Purity argon is used as the inductively coupled plasma (ICP) torch gas with the Helios system. The quality criteria for argon are listed in Table 7.

Table 7: Argon requirements

	Gas Specification
Argon Purity	≥99.996%
Impurity Content	
Oxygen	<5 ppm
Hydrogen	<1 ppm
Nitrogen	<20 ppm
Water	<4 ppm

Argon gas at 80 ± 1 psi (522 ± 7 kPa) is to be supplied to the Helios system from liquid or compressed gas storage tanks at a flow rate of approximately 20 L/min. The choice of liquid argon or compressed gas argon tanks is determined primarily by the availability of each and the usage rate. A regulator able to provide a pressure range of 0–100 PSI is required with a ¼ inch Swagelok termination. Mechanical pressure regulators are recommended for the argon supply.

NOTE A liquid cryogenic argon tank is preferred.

IMPORTANT Do not use electronic pressure regulator and auto-switching valves, because they may affect the plasma stability and may also result in frequent loss of plasma.



WARNING It is recommended to install an oxygen sensor in the room where the operator and gas storage are located.

Safe Handling of Gas Cylinders

The permanent installation of gas supplies is the responsibility of the user and should conform to local safety and building codes. The following are a list of safety precautions that should be observed when handling argon gas cylinders.

- Fasten all gas cylinders securely to an immovable bulkhead or a permanent wall.
- When gas cylinders are stored in confined areas, ventilation should be adequate to prevent dangerous accumulations. Move or store gas cylinders only in a vertical position with the valve cap in place.
- Locate gas cylinders away from heat or ignition sources, including heat lamps. Cylinders have a pressure relief device that will release the contents of the cylinder if the temperature exceeds 52 °C (125 °F).
- When storing cylinders external to a building, the cylinders should be stored so that they are protected against temperature extremes (including the direct rays of the sun) and should be stored above ground on a suitable floor.
- Gas cylinders should be clearly marked to identify the contents and status (e.g., full, empty).
- Do not attempt to refill gas cylinders.
- Use only approved mechanical regulators and hose connectors. Left-hand thread fittings are used for fuel gas tank connections, whereas right-hand fittings are used for oxidant and support gas connections.
- Arrange gas hoses away from foot traffic to avoid damage.
- Perform periodic gas leak tests by applying a soap solution to all joints and seals.

Exhaust Requirement

The main venting system is required to remove fumes and vapors from the torch housing. Exhaust venting is important for four reasons:

- It protects laboratory personnel from ozone and hot argon generated in plasma.
- It minimizes the effects of room drafts and the laboratory atmosphere on ICP torch stability.
- It helps protect the instrument from corrosive vapors that may originate from the samples.
- It removes dissipated heat produced by the ICP torch, ICP power supply, and pump motors.

Exhaust Positions

The air intake vent located on the lower front door of the instrument allows for ambient air to enter the system. This air, with the aid of a fan located on the inside of the vent, provides additional cooling for the pumps.

The Helios system has two separate exhaust vents, both of which are located at the back of the instrument as shown in Figure 3.

The torch box vent exhausts plasma and the vacuum pump system. It removes fumes and vapors from the torch housing and the rough pump exhausts. The torch box vent is 100 mm or 4 inches in diameter.

The system vent exhausts heat from the blower that cools the roughing pumps, system power supply, and radio frequency generator. The system vent is 150 mm or 6 inches in diameter.

Table 8: Exhaust positions

Exhaust Vent	Hose Diameter. mm (in)	Distance from the Ground cm (in)
Torch Box	100 (4)	112 (44)
System	150 (6)	38 (15)

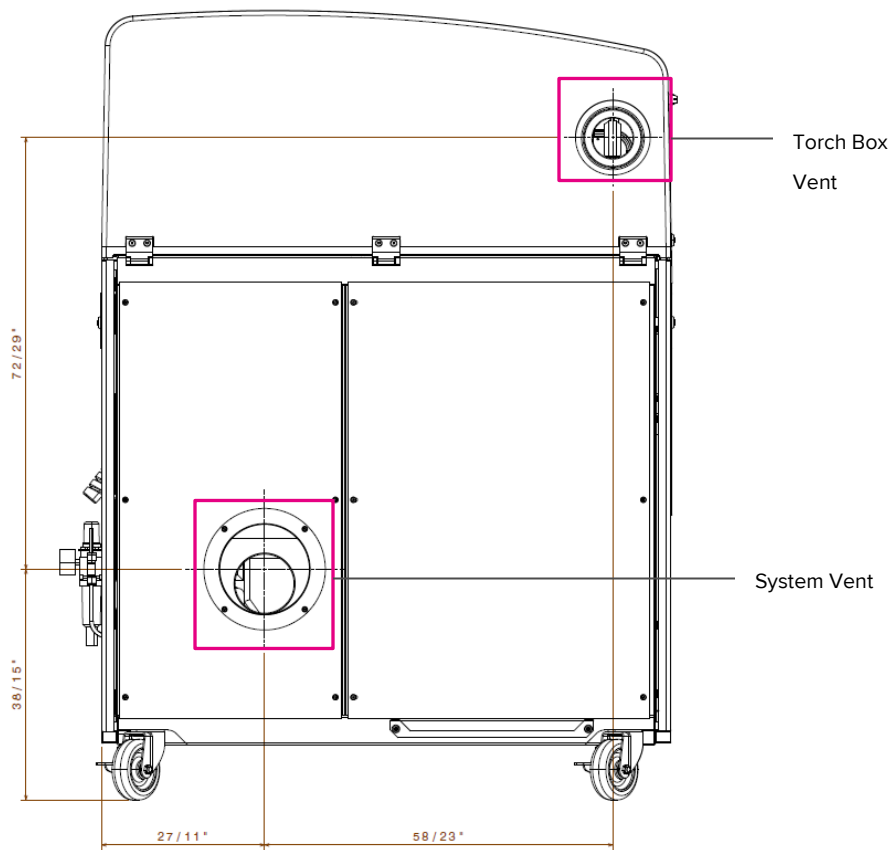

Figure 3: Instrument rear view drawing with exhaust vent positions highlighted in magenta, torch box vent (top), and system vent (bottom)

Flow Rates

The Helios instrument is supplied with 3.6 m (12 ft) of 100 mm (4 in) and 3.6 m (12 ft) of 150 mm (6 in) flexible hoses. A venting system that uses a single inlet duct, having a flow rate of 280 L/sec (600 cfm), should be divided into the two separate 100 mm (4 in) and 150 mm (6 in) ducts equipped with individual dampers. Ensure that there is access to the dampers during installation. Table 9 details the exhaust specifications.

Table 9: Exhaust specifications

Vent	Hose Diameter. mm (in)	Flow Rate L/sec (cfm)	Anemometer m/sec (ft/min)	Vented Outside Lab Power W (BTU/hr)
Torch Box	100 (4)	70 +/-10% (150)	9 (1,695)	200 (690)
System	150 (6)	210 +/- 10% (450)	11.5 (2,250)	2,800 (9,400)

The flow rates as measured with the hoses connected to the ducts will need to be verified and adjusted during installation of the instrument. The static pressure drop caused by the Helios system is 1.2 inches H₂O (200 Pa).

Exhaust System Recommendations

The exhaust flow rate at the instrument (the ability to vent the system) is dependent on the blower provided by the customer, the duct length, the duct material, and the number of elbows or bends used. If an excessively long duct system or a system with many bends is used, a stronger blower may be necessary to provide sufficient exhaust volume at the instrument.

Additional recommendations on the venting system include:

- The duct casing and venting system should be made of materials suitable for temperatures as high as 70 °C (160 °F) and be installed to meet local building code requirements.
- Locate the blower as close to the discharge outlet as possible. All joints on the discharge side should be airtight.
- Equip the outlet end of the system with a backdraft damper.
- Take the necessary precautions to keep the exhaust outlet away from open windows or inlet vents and to extend it above the roof of the building for proper dispersal of the exhaust.
- Equip the exhaust end of the system with an exhaust stack to improve the overall efficiency of the system.

- For best efficiency, make sure the length of the duct that enters into the blower is a straight length at least 10 times the duct diameter. An elbow entrance into the blower inlet causes a loss of efficiency.
- Provide makeup air in the same quantity as is exhausted by the system. An airtight laboratory can cause an efficiency loss in the exhaust system.
- Ensure that the system is drawing properly by placing a piece of cardboard over the mouth of the vent

NOTE The heat vented out of the lab due to the operation of Helios is approximately 3,000 W.

Environmental Requirements

The Helios system has been designed for indoor use only. The environment in which the instrument is installed should meet the following conditions:

Room temperature: The room temperature should be between 15 and 30 °C (59 and 86 °F) with a maximum rate of change of 2.8 °C (5 °F) per hour.

NOTE For optimal performance the temperature should be 20 °C ±2.

Relative humidity: The relative humidity should be between 20% and 80%, noncondensing.

Elevation: The instrument should not be operated at an elevation greater than 2,000 m (6,500 ft) above sea level. Use of the instrument at elevations greater than 2,000 m is subject to acceptance by local inspection authorities.

The instrument should be located in an area that is:

- free of smoke and corrosive fumes,
- not prone to excessive vibration,
- out of direct sunlight,
- away from direct sources of heating or cooling.



WARNING Do not use the instrument in an area where explosion hazards may exist.

Additional Site Recommendations

Institutional network connectivity

Enabling network connectivity to the instrument workstation allows for more efficient transfer of instrument data through the Ethernet network port of the instrument workstation. Contact your site IT Department.

IMPORTANT Data should not be written directly to a Network Drive during sample acquisition and must be written directly to the instrument workstation. Data may only be transferred/shared via network connection upon completion of sample acquisition.

Internet connectivity

It is highly recommended that you have the Helios instrument computer on a network with internet connection so that the Fluidigm Support team can better assist you and your team and to facilitate remote diagnostics of the instrument. Please work with your IT department to ensure that internet connectivity can occur prior to installation. Access to the internet can greatly reduce instrument down time and unanticipated field service/repair costs. Under no circumstance will Fluidigm be able to access the instrument, or associated data stored on the workstation, without the end user's express permission.

Telephone access

If internet connection is unavailable and mobile telephone reception is poor, it is recommended that you provide a landline phone in the immediate vicinity of the instrument workstation.

Materials Required for Operation

Table 10 provides a list of the materials supplied with the instrument for the installation and operation of the instrument.

Table 10: Materials supplied for Helios instrument installation and operation

Description	Supplier	Product Number	Quantity
Tuning Solution, CyTOF, E-Pure, 250 mL	Fluidigm	201072	~10 mL
Washing Solution, 250 mL	Fluidigm	201071	~10 mL
EQ 4-Element Beads	Fluidigm	201073	5–10 mL
Milli-Q™ High Quality 18, Deionised Water (DIW) of Highest Grade 18.2 MOhm	Milli-Q (Millipore)	R00001	Constant supply
5mL Round Bottom Tubes with 35 µm Mesh Cell Strainer (12 x 75 mm)	Fluidigm	352235	1 per sample
5mL Round Bottom Tubes with Solids Caps (12 x 75 mm)	Fluidigm	352054	1 per sample
Powder-Free Gloves			
50 mL Screw Cap Tube, Polypropylene	VWR	101093-574	
15 mL Tube			
Tuning Cells	Fluidigm		2
Isopropanol, 100%			100–200 mL
Kimwipes®			

Summary

Table 11 provides a summary of the requirements for the successful installation of your Helios system.

Table 11: Helios installation summary

Dimensions	Width (cm/in)	Height (cm/in)	Depth (cm/in)	Weight (kg/lb)
Helios Crate	107/42	157/62	170/67	529/1,166
Helios	103/41	132/52	87/35	320/705
Chiller	38/15	64/25	67/27	81/178
Component Box	81/32	97/38	107/42	135/298

Electrical	Voltage (V AC)	Current (A)
Helios	200/208/220/230/240	2 x 30
Computer	100–240	6
Monitor	100–240	6

Gas	Purity	Pressure	Flow
Argon	≥99.996%	80 ±1 psi	20 L/min

Exhaust	Hose (mm/in)	Flow Rate (L/sec; cfm)	Anemometer (m/sec; ft/min)	Vented Outside Lab Power (W; BTU/hr)
Torch Box	100; 4	70 +/-10%; 150	9; 1,695	200; 690
System	150; 6	210 +/-10%; 450	11.5; 2,250	2,800; 9,400

Appendix A: Safety

General Safety

In addition to your site-specific safety requirements, Fluidigm recommends the following general safety guidelines in all laboratory and manufacturing areas:

- Personal protective equipment (PPE): safety glasses, fully enclosed shoes, lab coats, and gloves.
- Know the locations of all safety equipment (fire extinguishers, spill kits, eyewashes/showers, first aid kits, safety data sheets, etc.), emergency exit locations, and emergency/injury reporting procedures.
- No eating, drinking, or smoking in lab areas.
- Maintain clean work areas.
- Wash hands before leaving the lab.



WARNING Helios is designed for analysis of fixed/permealized, nonlive cells only. Under normal operation, cells are completely combusted in the ICP. High levels of UV radiation inside the torch box are significantly above the lethal levels for most single airborne cells. However, in the event of plasma shutdown, the nonionized portion of a sample can enter the torch box exhaust gases. Extreme care should be taken to vent exhaust gases appropriately.

Instrument Safety











WARNING Do not modify this device. Unauthorized modifications may create a safety hazard.



WARNING BIOHAZARD. If you are putting biohazardous material on the instrument, use appropriate personal protective equipment and adhere to *Biosafety in Microbiological and Biomedical Laboratories* (BMBL) from the Centers for Disease Control and Prevention and to your lab's safety protocol to limit biohazard risks. If biohazardous materials are used, properly label the equipment as a biohazard. For more information, see the BMBL guidelines online at: cdc.gov/biosafety/publications/index.htm

Instrument Symbols

Symbol	English	Français
	Warning, risk of danger Consult the manual for further safety information.	Attention, risque de danger Consulter le manuel pour d'autres renseignements de sécurité.
	Caution, hot surface	Attention, surface chaude
	Pinch hazard	Risque de pincement
	Biohazard	Risque biologique
	On/off	On/off (marche/arrêt)
	Protective conductor terminal (main ground). It must be connected to earth ground before any other electrical connections are made to the instrument.	Borne de conducteur de protection (mise à la terre principale)

Conformity mark	Description
	Indicates conformity with an OSHA-recognized Nationally Recognized Test Lab (NRTL) for safety certification in North America.
	Indicates conformity with European Union requirements for safety and electromagnetic compatibility.

Chemical Safety



WARNING Read and comprehend all safety data sheets (SDSs) by chemical manufacturers before you use, store, or handle any chemicals or hazardous materials.



WARNING Wear personal protective equipment (gloves, safety glasses, fully enclosed shoes, lab coats) when handling chemicals.



WARNING Do not inhale fumes from chemicals. Use adequate ventilation, and return caps to bottles immediately after use.



WARNING Check regularly for chemical spills or leaks. Follow SDS recommendations for cleaning up spills or leaks.



For technical support visit fluidigm.com/support